

## Moaré

Antoni Arola. 2003  
Pendant lamps

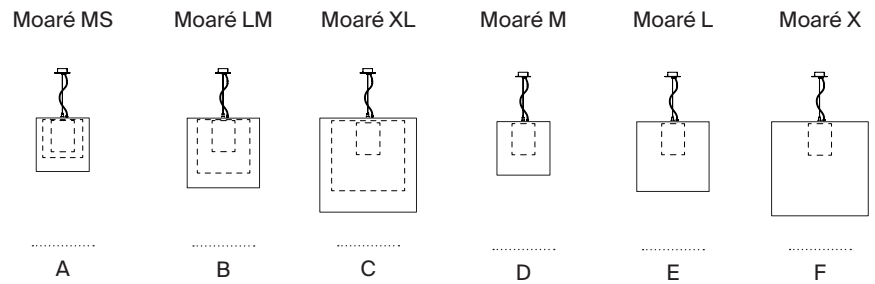

### Lampshades:

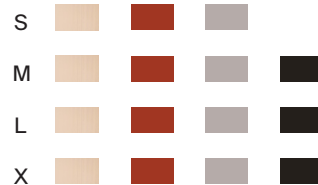

### Canopies:

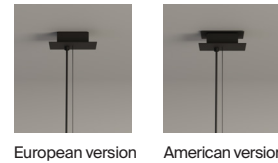

The Moaré series takes its name from the iridescent effect achieved by the two cylindrical shades, which create optical illusions as their textures react against the light. Today, the collection includes a range of colours and formats for a wide variety of uses. An interplay of transparency and colours. The pendant and the floor versions both feature three central bulbs and an interior diffuser that ensures the brightness is diluted.

### General description:

Two superimposed cylindrical polyester lampshades.  
With a range of sizes and colours (white, red, grey and black), numerous combinations are possible.  
Aluminium structure with graphite black finish and cast aluminium base.  
Acrylsatine methacrylate cylindrical diffuser. Metallic graphite black square canopy.  
Suitable for Junction Box (American version).  
Electric cable length: 3 m / 118.1"

### Approximate weight (unpacked):

(A) Moaré MS: 5,5 kg / 12.1 lb  
(B) Moaré LM: 6,3 kg / 13.9 lb  
(C) Moaré XL: 7,8 kg / 17.2 lb  
(D) Moaré M: 4,5 kg / 9.9 lb  
(E) Moaré L: 4,8 kg / 10.6 lb  
(F) Moaré X: 6 kg / 13.2 lb

### Technical information:

European version: Light source included  
American version: Recommended light source (not included)

3 x LED bulb: 11 W / 1.521 lm / 2700K  
E27 - E26 / Max. hgt. 130 mm / 5.1"

Suitable only for indoor use.  
Always use the light source recommended or equivalent.

Input voltage: 100, 120, 230 Vac.  
(50 Hz / 60 Hz). According to destination.

# Moaré

Antoni Arola. 2003  
Pendant lamps

## Regulations:

European version  
UNE-EN 60598  
UNE-EN 55015  
UNE-EN 60529

American version  
Dry location only  
UL-1598  
E-353545

## Maintenance:

Clean with a smooth cloth. Do not use ammonia, solvents or abrasive cleaning products.

## Others:

The lamp is delivered in different packages.  
The assembly instructions are delivered with the product.

## Models (European version)

### Model A: Moaré MS

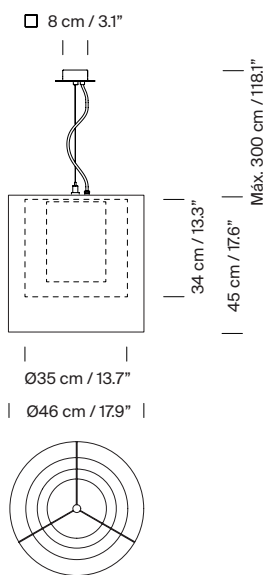

### Model B: Moaré LM

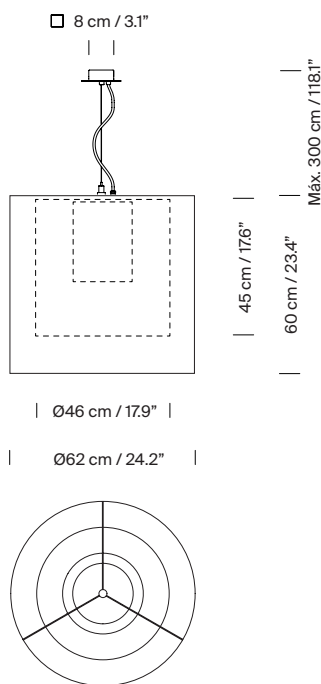

### Model C: Moaré XL

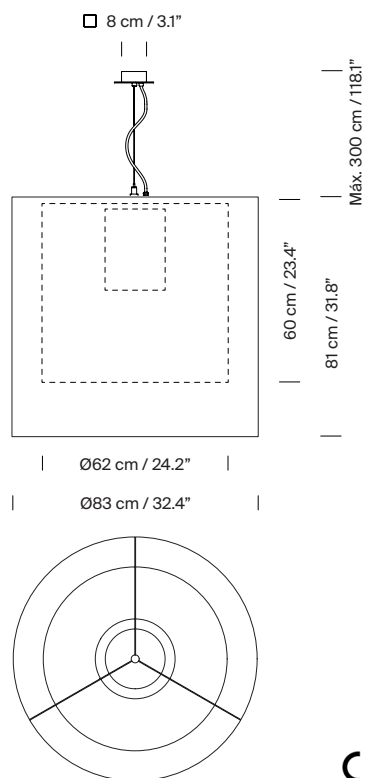

CE

**Model D: Moaré M**

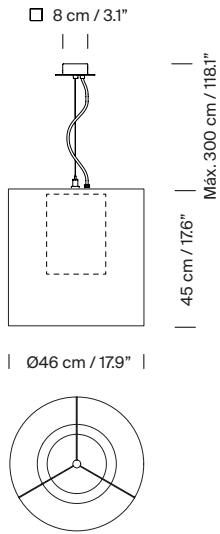

**Model E: Moaré L**

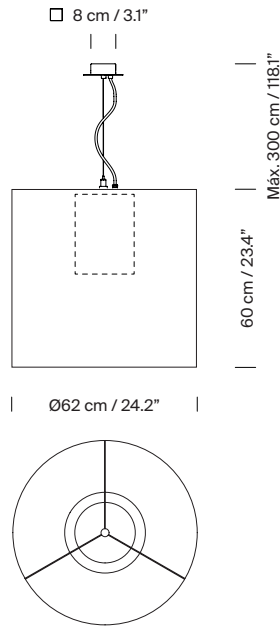

**Model F: Moaré X**

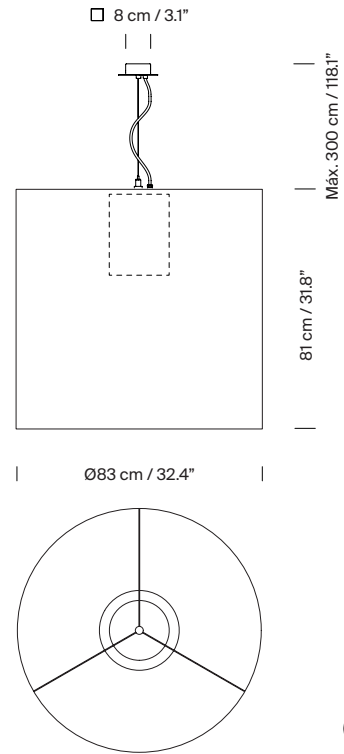

**Models (American version):**

**Model A: Moaré MS**

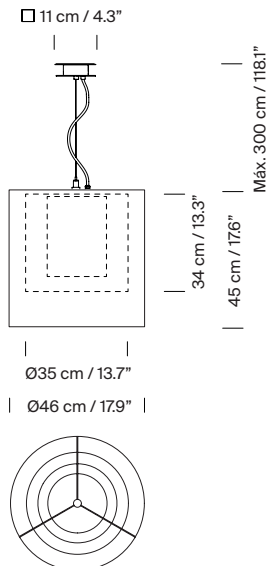

**Model B: Moaré LM**

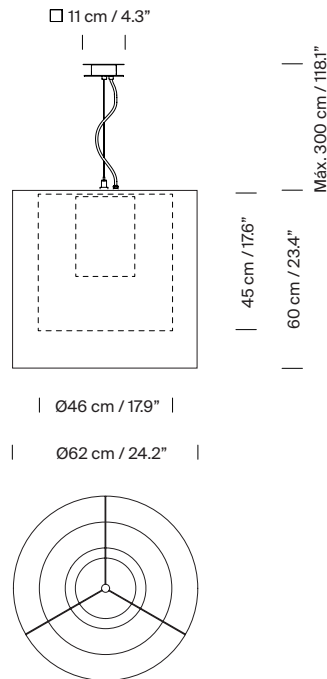

**Model C: Moaré XL**

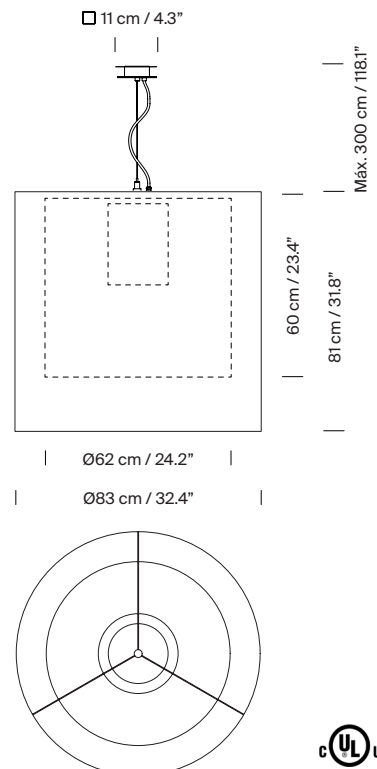

**Model D: Moaré M**

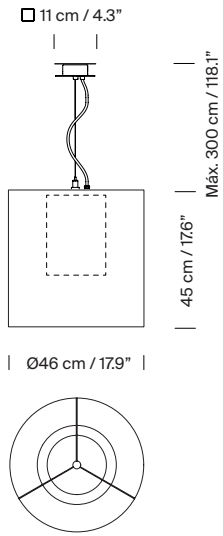

**Model E: Moaré L**

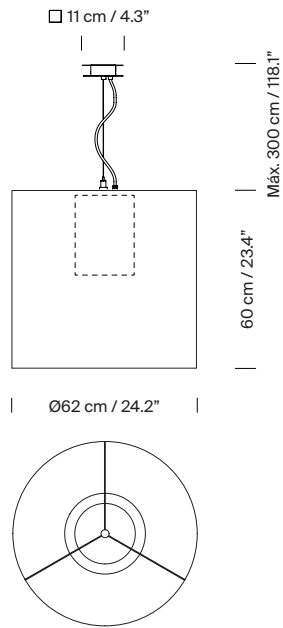

**Model F: Moaré X**

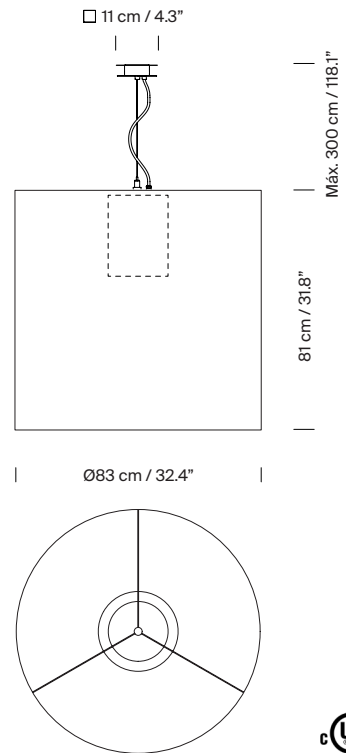

**Collection:**  
 Pendant lamps



Moaré



Moaré Liviana